

Specification Name:

Infernoguard 30 Minute Fire Rated Hinged Pair – Timber Stud

Code: IF30HPT

Fire Resistance Rating (FRR): -/30/30sm

Description:

Infernoguard 30 is a double prehung fire doorset comprised of a composite timber core faced with various materials.

Leaf Sizes & Wall Types:

Wall Type	Height	Width	Jamb Type
Timber Stud (Leaf area cannot exceed 2.2m ²)	2400	910	Timber

Minimum Wall Specification: Timber Stud Ex 70x45 with 10mm fire rated plasterboard to each side of wall to manufacturer’s installation instructions.

Leaf Specifications:

- Leaf Weight: 29kg m²
- Leaf Thickness: 46mm

Leaf Facings Options:

- MDF 4.75mm
- Standard Masonite 4.8mm
- Oil Tempered Masonite 4.8mm
- Plywood 4mm
- High Pressure Laminates (HPL) up to 0.8mm fixed to faces only.
- Continuous Pressed Laminates (CPL) up to 0.2mm fixed to faces only.
- Timber Veneers

Additional Leaf Facing Options:

- Acrovyn up to 1.6mm – includes edge capping to single doors
- V Groove & U Grooves – up to 2mm deep (Spacings 100mm apart Minimum)
- Square Groove routed in the leaf facing - up to 22mm wide & 3mm deep (Spacings 100mm apart Minimum)
- Standard or Stainless steel facing up to 1.2 mm can be surface mounted. Must be set back from edge of the door by 5mm minimum.
- 4.75mm or 6mm MDF Raised Panels to edges
- Up to 18mm Timber Raised Panels

Leaf Edge Options:

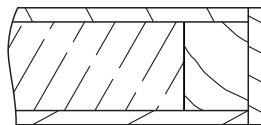

E1 - Solid Timber Clashing

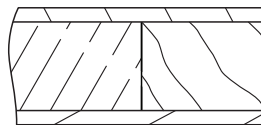

E2 - Internal Timber Rail

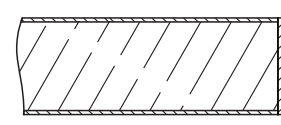

E3 - PVC Clashing

Meeting Stile Options:

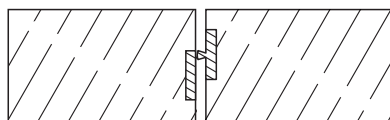

MS1 - Unclashed Flush Stiles

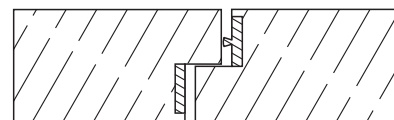

MS2 - Unclashed Rebated Stiles

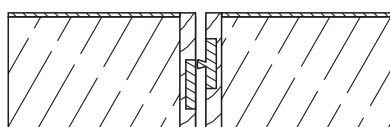

MS3 - Clashed Flush Stiles

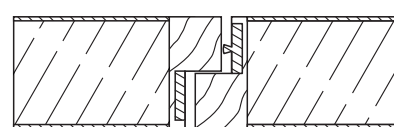

MS4 - Clashed Rebated Stiles

Timber - Jamb/Door Frame Options:

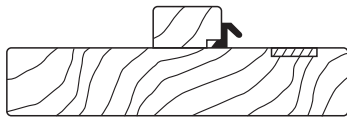

J1

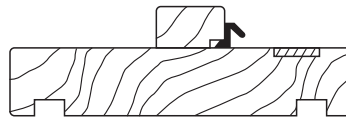

J2

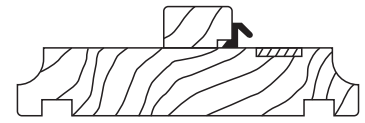

J2a

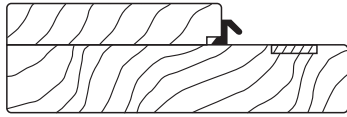

J4

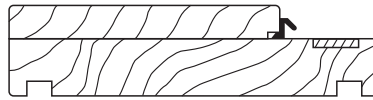

J4a

Vision Panels/Glazing Options:

Glazed vision panels using the following glass types are permitted. Sizing rules are set out in table below.

	Max Height	Max Width	Max Area
15mm Pyranova Insulating Glass	1775mm	500mm	0.85m ²

- Single Vision Panels - Max Height, Width & area to apply
- Multiple Vision Panels - Max height & width to be applied to individual panes. Max area to be applied to total area of glazing.
- Vision panels must be a minimum of 170mm from any edge of the door
- For multiple vision panels there must be 170mm between panes
- Vision panel cutout to be a minimum of 50mm from any hardware cutout
- Vision panels available in square or rectangle options

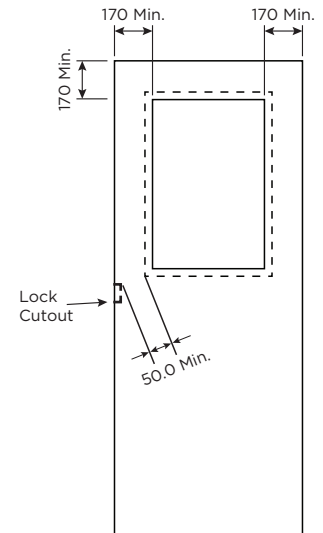

Glazing Bead Options:

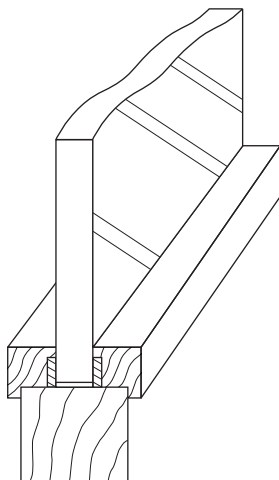

B1 - Timber Beading

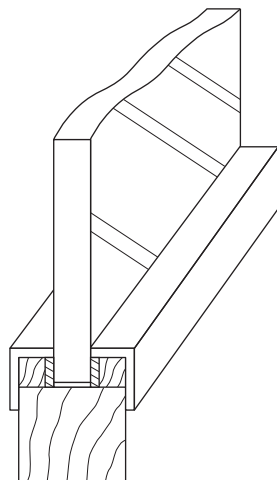

B2 - Aluminium Beading

Grille Size Options:

Grilles are not designed for exterior applications, or to be weather sealing. They are recommended for interior applications only.

- Grilles are to be mounted in bottom of doors
- Grille cutouts must be a minimum of 100mm from any edge of the door and 150mm up from the base of the door
- Available size 450mm high x 450mm wide

Dropseal Options:

See approved hardware list. Copy available on request.

Installation Packing:

- Infernoguard Mastic
- Infernoguard Rokstop

Approved Hardware:

A broad range of hardware has been tested or approved on Infernoguard 30 doorsets. See approved hardware list on website.

Building Code/Technical Statement:

Infernoguard 30 products have undergone successful testing by IANZ Testing Laboratory in accordance with AS1530.4 -2005/2014, as referenced in NZS 4520:2010 and in Building Code Acceptable Solutions C/AS2 Appendix C5.1.1a & C6.1.1

Infernoguard door sets when installed in line with Soteria Doors installation instructions into a compliant fire-resistant wall, and when fitted with Soteria Doors approved hardware will comply with NZS 4520:2010.

This door is not tested for water ingress in exterior installations and we make no statement as to its suitability under NZBC E2 "External moisture". All exterior doors should be given as much shelter as possible and be fitted with appropriate flashing systems.

The Infernoguard range will, if employed in accordance with Soteria Doors installation and maintenance requirements, assist with meeting the following provisions of the building code:

- NZBC C/AS2
- NZS 4232.2
- AS 1530.4
- NZS 4520
- NZS 4223.3:2016

Environmental - Doors include:

- Timber core which is FSC certified
- E0 MDF which is FSC certified
- FSC certified timber rails
- Non-Toxic PVA Bonding Agent

Supporting Documentation:

- BRANZ Tests: FR3927, FR4040, FR4151, FR4157, FP4158, FP4159, FP4330, FR5165, FP5664, FP5846, FP6203, FP10050-001, FP11337-001, FP12135-001, FP15556
- BRANZ Assessments: FAR3412, FAR3829, FC13020-001
- BRANZ Technical Opinion Summary FC13932-001 Issue 1
- 5 Year Warranty Materials & Workmanship Warranty
- Installation Instructions