

Specification Name:

Infernoguard Smoke Rated Hinged Single – Masonry Wall

Code: IFSMHSM

Fire Resistance Rating (FRR): -/-/-sm

Description:

Infernoguard Smoke is a single prehung fire doorset comprised of a composite timber core faced with various materials.

Leaf Sizes & Wall Types:

Wall Type	Height	Width	Jamb Type
Masonry Wall	2700	1200	Timber

Minimum Wall Specification:

Precast concrete of 120mm or grouted blockwork of 120mm thickness

Leaf Specifications:

- Leaf Weight: 29kg m²
- Leaf Thickness: 40mm

Leaf Facings Options:

- MDF 4.75mm
- Standard Masonite 4.8mm
- Oil Tempered Masonite 4.8mm
- Plywood 4mm
- High Pressure Laminates (HPL) up to 0.8mm fixed to faces only
- Continuous Pressed Laminates (CPL) up to 0.2mm fixed to faces only
- Timber Veneers

Additional Leaf Facing Options:

- Acrovyn up to 1.6mm – includes edge capping to single doors
- V Groove & U Grooves – up to 2mm deep (Spacings 100mm apart Minimum)
- Square Groove routed in the leaf facing – up to 22mm wide & 3mm deep (Spacings 100mm apart Minimum)
- Standard or Stainless steel facing up to 1.2 mm can be surface mounted
 Must be set back from edge of the door by 5mm minimum
- 4.75mm or 6mm MDF Raised Panels to edges
- Up to 18mm Timber Raised Panels

Leaf Edge Options:

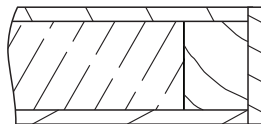

E1 - Solid Timber Clashing

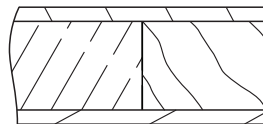

E2 - Internal Timber Rail

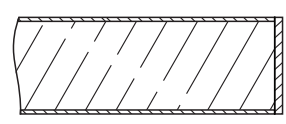

E3 - PVC Clashing

Timber - Jamb/Door Frame Options:

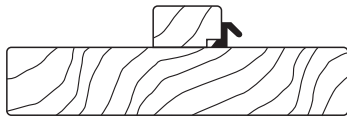

J1

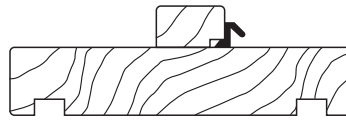

J2

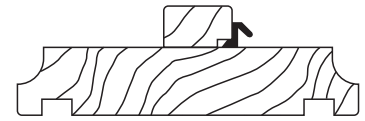

J2a

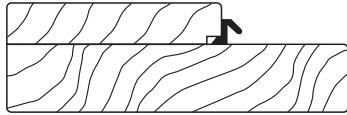

J4

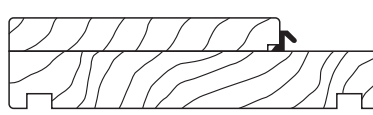

J4a

Vision Panels/Glazing Options:

Glazed vision panels using the following glass types are permitted. Sizing rules are set out in table below.

	Max Height	Max Width	Max Area
6.38mm Clear Laminate	No Limitation	No Limitation	No Limitation
10.38mm Clear Laminate	No Limitation	No Limitation	No Limitation

- Vision panels must be a minimum of 170mm from any edge of the door
- For multiple vision panels there must be 170mm between panes
- Vision panel cutout to be a minimum of 50mm from any hardware cutout
- Vision panels available in square, rectangular or circular options

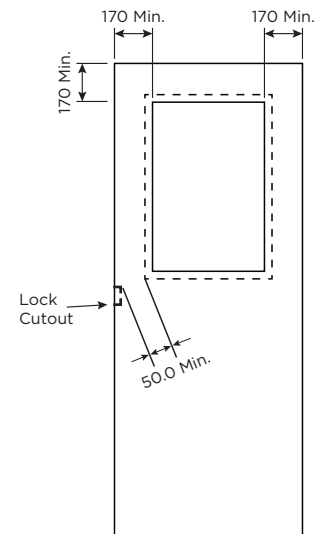

Glazing Bead Options:

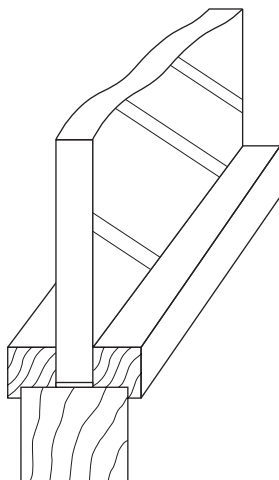

B3 - Timber
Beading

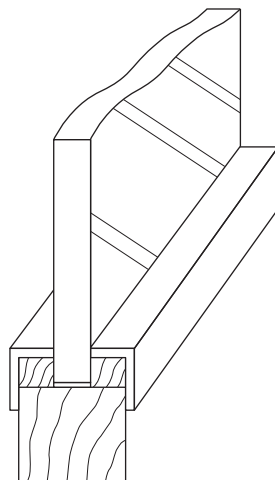

B4 - Aluminium
Beading

Grille Size Options:

Grilles are not designed for exterior applications, or to be weather sealing. They are recommended for interior applications only.

- Grilles are not available in a smoke door as they will surrender the smoke rating.

Dropseal Options:

See approved hardware list on website.

Approved Hardware:

A broad range of hardware is approved on Infernoguard smoke doorsets. See approved hardware list on website.

Building Code/Technical Statement:

Infernoguard door sets when installed in line with Soteria Doors installation instructions into a compliant wall, and when fitted with Soteria Doors approved hardware will comply with NZS 4520:2010.

This door is not tested for water ingress in exterior installations and we make no statement as to its suitability under NZBC E2 "External moisture". All exterior doors should be given as much shelter as possible and be fitted with appropriate flashing systems.

The Infernoguard range will, if employed in accordance with Soteria Doors installation and maintenance requirements, assist with meeting the following provisions of the building code:

- NZBC C/AS2
- AS 1530.4
- NZS 4223.3:2016
- NZS 4232.2
- NZS 4520

Environment - Doors include:

- Timber core which is FSC certified
- E0 MDF which is FSC certified
- FSC certified timber rails
- Non-Toxic PVA Bonding Agent

Supporting Documentation:

- 5 Year Warranty Materials & Workmanship Warranty
- Installation Instructions